

ROD FLOOR 120

BARRIERA SINGOLA
SINGLE-RAIL BARRIER

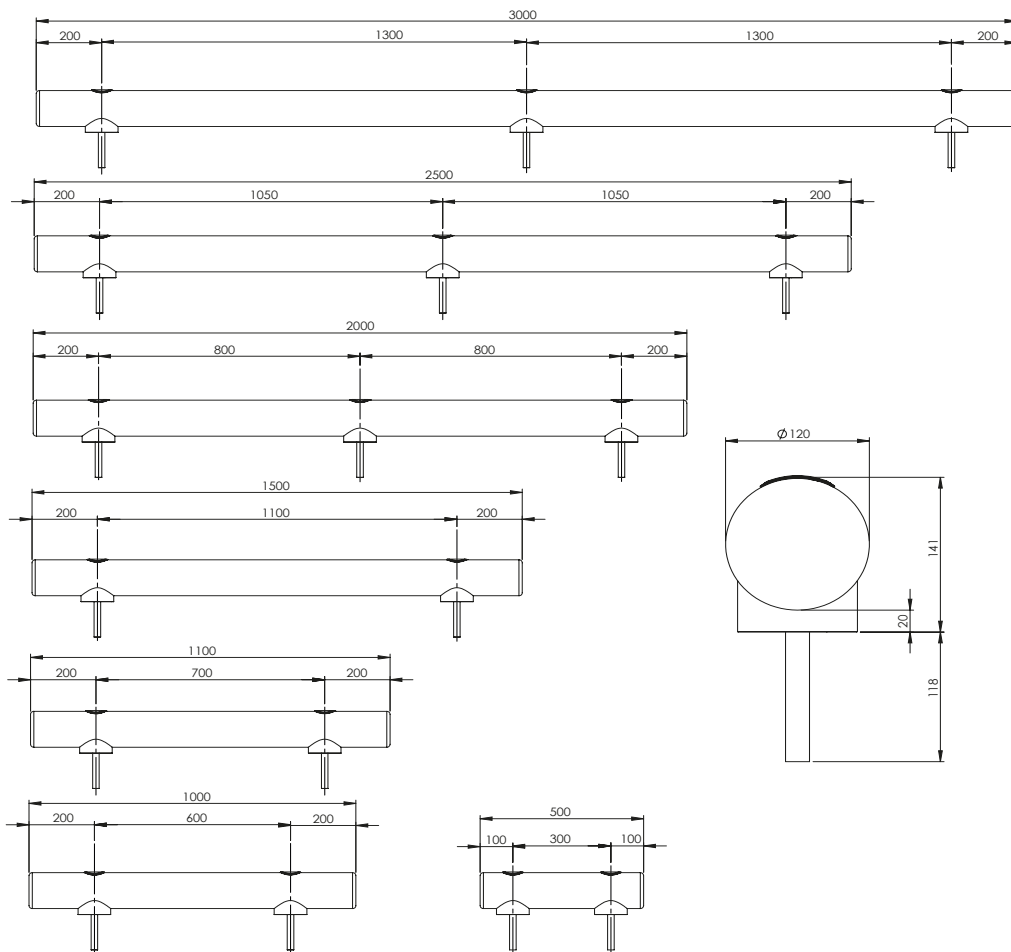

RESISTANT TO
LOW TEMPERATURES

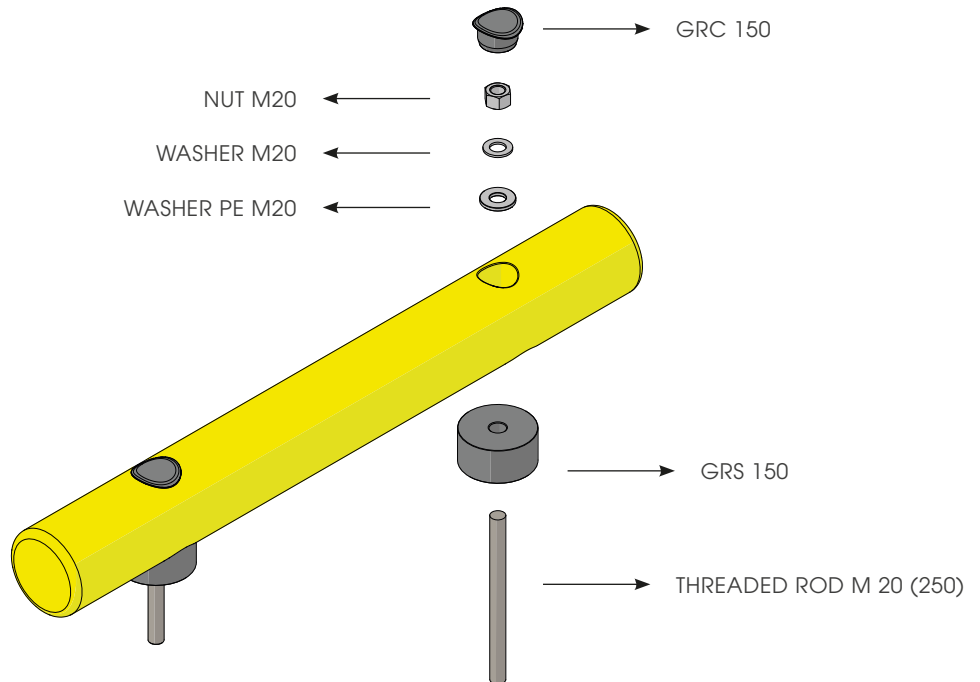

ROD FLOOR 120

ISTRUZIONI DI INSTALLAZIONE
ASSEMBLY INSTRUCTIONS

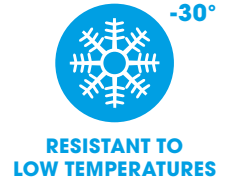

ONLY WITH RESIN

CHEMICAL
ANCHOR

Ø24 mm

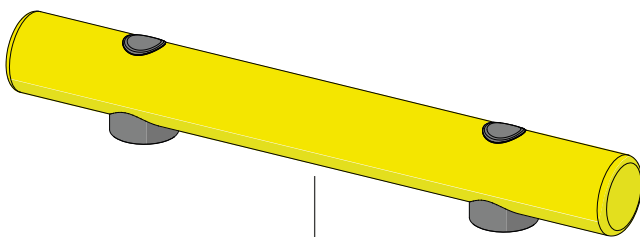
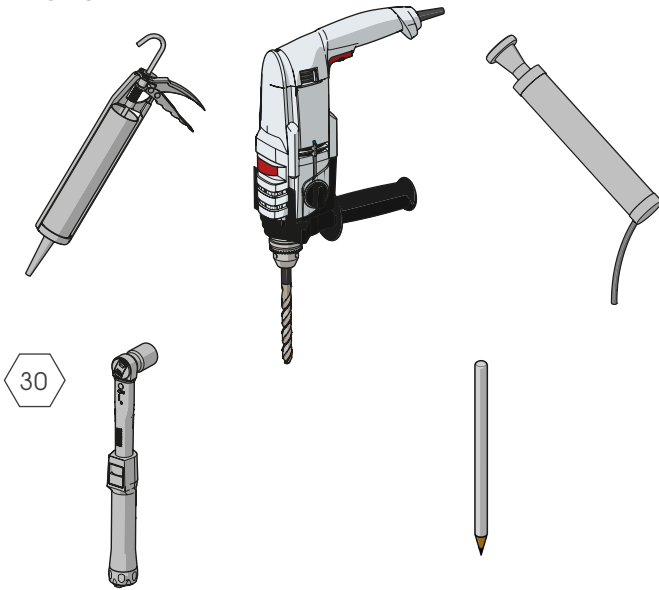

WARNING

The distance of installation depends on speed and weight of vehicle

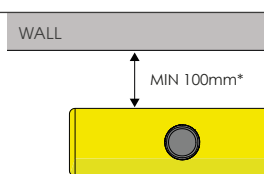

1

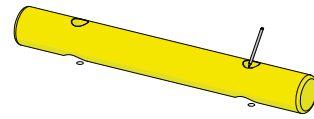

2

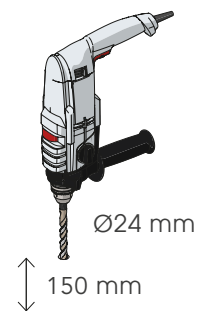

3

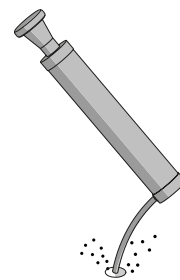

4

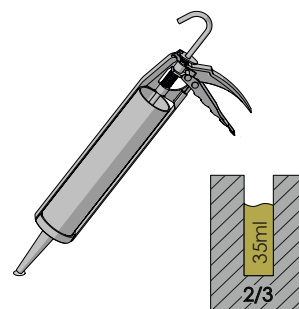

ROD FLOOR 120

ISTRUZIONI DI INSTALLAZIONE
ASSEMBLY INSTRUCTIONS

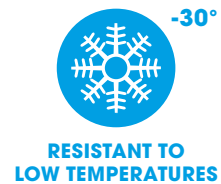

ONLY WITH RESIN

