

05. PEDESTRIAN SAFETY BARRIERS

PED 150

BARRIERA DI SICUREZZA
SAFETY BARRIER

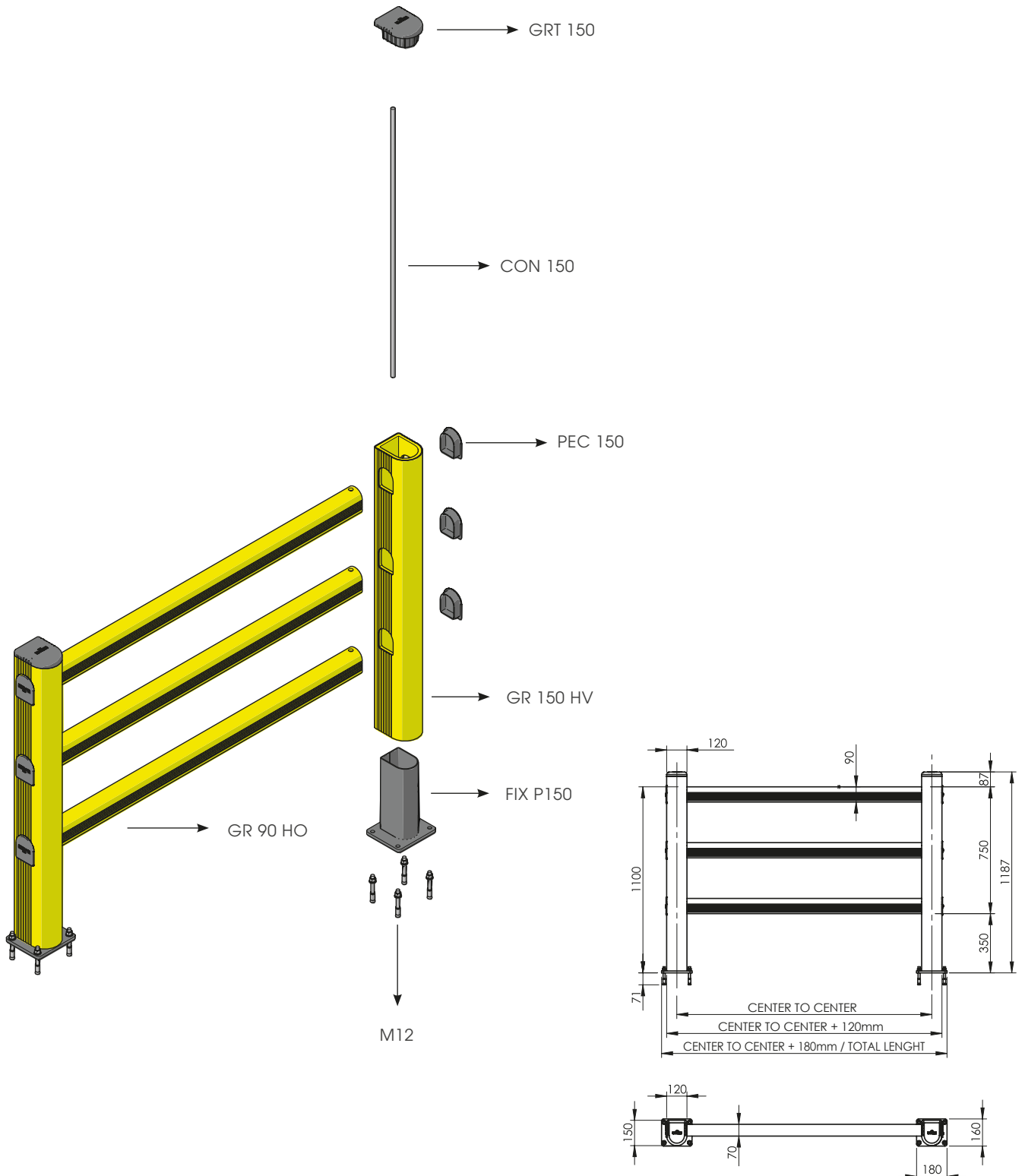

PED 150

ISTRUZIONI DI INSTALLAZIONE
ASSEMBLY INSTRUCTIONS

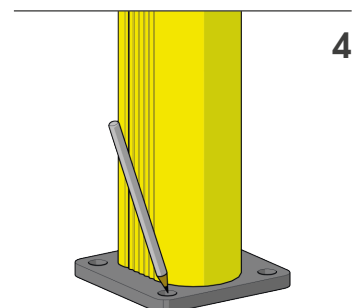
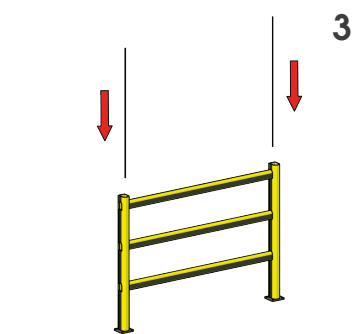
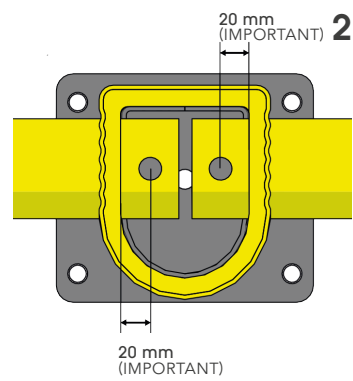
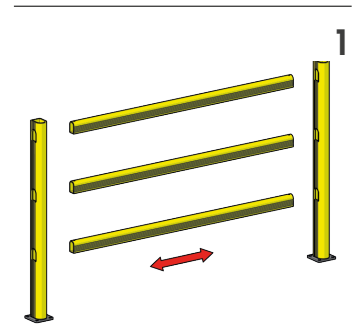
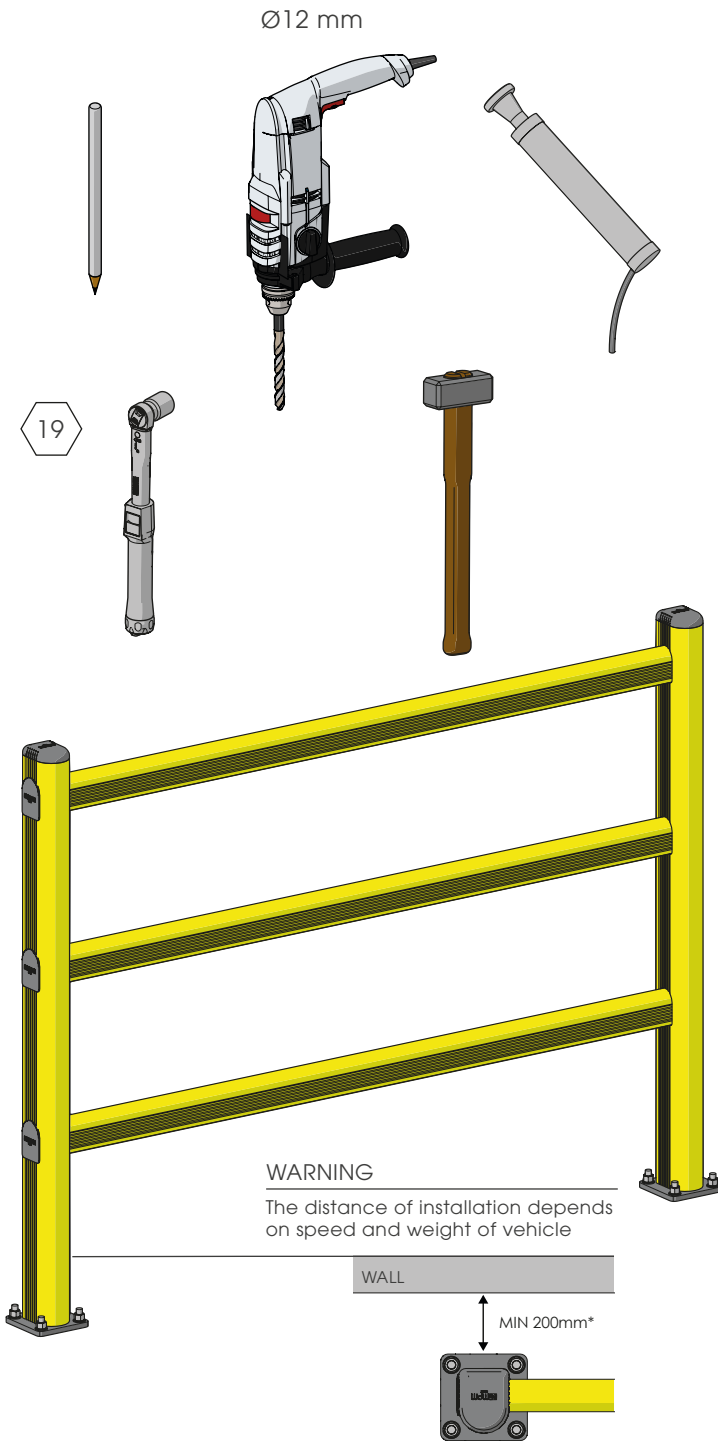

PED 150

ISTRUZIONI DI INSTALLAZIONE
ASSEMBLY INSTRUCTIONS

